



Operator's Manual



Model 4610HD

Important Safety Instructions

Dear SunBriteTV Customer:

Congratulations on your ownership of the SunBriteTV Model 4610HD. This product is designed as a weatherproof LCD television that can be installed outdoors. To ensure safety and minimize mechanical malfunctions of your product, please read the Important Safety Instructions carefully before using this product.

IMPORTANT SAFETY INSTRUCTIONS

- 1) Read these instructions.
- 2) Keep these instructions.
- 3) Heed all warnings.
- 4) Follow all instructions.
- 5) Do not block any ventilation openings. Install in accordance with the manufacturer's instructions.
- 6) Do not install near any heat sources such as radiators, heat registers, stoves, or other apparatus (including amplifiers) that produce heat.
- 7) Do not defeat the safety purpose of the polarized or grounding-type plug. A polarized plug has two blades with one wider than the other. A grounding type plug has two blades and a third grounding prong. The wide blade or the third prong are provided for your safety. If the provided plug does not fit into your outlet, consult an electrician for replacement of the obsolete outlet.
- 8) Protect the power cord from being walked on or pinched particularly at plugs, convenience receptacles, and the point where the cord exits from the apparatus.
- 9) Only use attachments/accessories specified by the manufacturer.
- 10) Use only the cart, stand tripod, bracket, or table specified by the manufacturer, or sold with the apparatus. When a cart is used, use caution when moving the cart/apparatus combination to avoid injury from tip-over.
- 11) Unplug this apparatus during lightning storms or when unused for long periods of time.
- 12) Refer all servicing to qualified service personnel. Servicing is required when the apparatus has been damaged in any way, such as power-supply cord or plug is damaged, liquid has been spilled or objects have fallen into the apparatus, the apparatus has been exposed to rain or moisture, does not operate normally, or has been dropped.



WARNING: TV must be plugged into a GFCI receptacle (safety-switch or trip-switch). TV and GFCI RECEPTACLE MUST BE INSTALLED NO LESS THAN 1.6 METERS FROM ANY BODY OF WATER (SUCH AS POOL OR SPA). Check local building codes for proper installation guidelines.

WARNING: This unit is equipped with a 3-pin grounded plug. The plug will only fit into a grounded power outlet. This is a safety feature. If you are unable to insert the plug into the outlet, contact your electrician. Do not alter this plug, as this will defeat the safety feature.

WARNING: The mains plug is used as the disconnect device and shall remain readily operable.

WARNING: This product shall be connected to a mains socket outlet with a protective earthing connection.

CAUTION: TO PREVENT ELECTRIC SHOCK, MATCH WIDE BLADE OF PLUG TO WIDE SLOT, FULLY INSERT.

WARNING: FCC Regulations state that any unauthorized changes or modifications to this equipment not expressly approved by the manufacturer could void the user's authority to operate this equipment.

NOTE TO CATV SYSTEM INSTALLER: This reminder is provided to call the CATV system installer's attention to Article 820-40 of the National Electrical Code that provides guidelines for proper grounding and, in particular, specifies that the cable ground shall be connected to the grounding system of the building, as close to the point of cable entry as practical.

WARNING: To reduce the risk of fire or electric shock, do not expose the inside of this apparatus to rain or moisture. The inside of this apparatus shall not be exposed to dripping or splashing, and no objects filled with liquids, such as vases, shall be placed on the apparatus.

This product utilizes tin-lead solder, and fluorescent lamp containing a small amount of mercury. Disposal of these materials may be regulated due to environmental considerations. For disposal or recycling information, please contact your local authorities.

Important Safety Instructions

Cleaning Instructions: Use a soft cloth with mild detergent in warm water to clean the SunBriteTV screen. Remove any dirt and salt deposits from the unit, being careful to rinse the cloth frequently to avoid scratching the screen surface. Avoid using harsh chemicals, ammonia, abrasives, or solvents when cleaning any surface on the screen. When the TV is not in use, it is important to keep it covered with the SunBriteTV fitted Outdoor Dust Cover. Use a soft brush or towel to remove snow and ice from the TV. In areas where dust or salt air is prevalent, it is recommended that the fiber filter be cleaned regularly (see instructions in Care section).





Attachments: Do not use attachments not specifically recommended by the manufacturer. Use of improper attachments can result in accidents.

Power Source: SunBriteTV must operate on a power source indicated on the specification label. If you are not sure of the type of power supply used in your home, consult your dealer or local power company. When using the TV outdoors, you must use a GFI-protected AC outlet with "in-use" waterproof cover.

Installation: Do not place the product on an unstable cart, stand, tripod, table, or anywhere the unit is not permanently installed. Placing the product on an unstable place can cause the product to fall, resulting in potential serious personal injuries, as well as damage to the product.

Precautions when Transporting the TV: Carrying the television requires at least two people.

WARNING: DO NOT IMMERSE TELEVISION IN WATER OR OTHER LIQUID. DO NOT INSTALL TV WITHIN 5 FEET OF BODY OF WATER (SUCH AS SPA OR POOL).

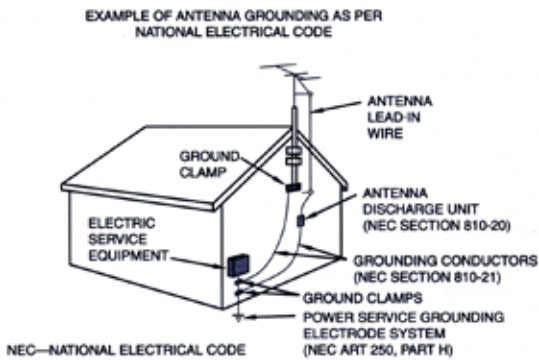
	<p>CAUTION RISK OF ELECTRIC SHOCK. DO NOT OPEN.</p> 	
<p>CAUTION: TO REDUCE THE RISK OF ELECTRIC SHOCK, DO NOT REMOVE COVER (OR BACK), FROM THE TELEVISION OR EXTERNAL POWER PACK, EXCEPT WHERE SPECIFIED IN THE MANUAL. NO USER-SERVICEABLE PARTS INSIDE. REFER SERVICING TO QUALIFIED SERVICE PERSONNEL.</p>		
		

The lightning flash with arrow-head symbol, within an equilateral triangle, is intended to alert the user to the presence of uninsulated "dangerous voltage" within the product's enclosure that may be of sufficient magnitude to constitute a risk of electric shock to persons.


The exclamation point within a triangle is intended to alert the user to the presence of important operating and maintenance (servicing) instructions in the literature accompanying the product.

IMPORTANT SAFETY PRECAUTIONS

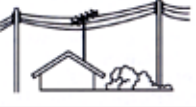
■ If an outside antenna is connected to the television equipment, be sure the antenna system is grounded so as to provide some protection against voltage surges and built-up static charges. Section 810 of the National Electrical Code provides information with respect to proper grounding of the mast and supporting structure, grounding of the lead-in wire to an antenna discharge unit, size of grounding conductors, location of antenna discharge unit, connection to grounding electrodes, and requirements for the grounding electrode.



■ For added protection for this television equipment during a lightning storm, or when it is left unattended and unused for long periods of time, unplug it from the wall outlet and disconnect the antenna. This will prevent damage to the equipment due to lightning and power-line surges.



■ An outside antenna system should not be located in the vicinity of overhead power lines or other electric light or power circuits, or where it can fall into such power lines or circuits. When installing an outside antenna system, extreme care should be taken to keep from touching such power lines or circuits as contact with them might be fatal.



Important Safety Instructions

Ventilation: Adequate ventilation must be maintained to ensure reliable and continued operation and to protect the television from overheating. Do not block ventilation slots and openings with objects, or install the television in a place where ventilation may be hindered. **SunBriteTV is not designed for built-in installation.** Do not place the product in an enclosed place such as bookcase or rack.

Power cord protection: The power cord must be routed properly to prevent people from stepping on it, or objects from resting on it. Check the cords at the plugs and product.

Power source: This product must operate on a power source specified on the specification label. If you are unsure of the type of power supply used in your home, consult your dealer or local power company.

Do not let metal pieces or objects of any kind fall into the television from ventilation holes. High voltage flows in the product, and inserting an object can cause electric shock and/or short internal parts.

Do not mount SunBriteTV near a motor or transformer where strong magnetism is generated. Images on the television will become distorted and the color irregular.

Do not mount SunBriteTV near heat sources such as radiators, heaters, stoves and other heat-generating products (including amplifiers).

Do not submerge SunBriteTV in water: The SunBriteTV will resist water exposure from normal rain, sprinklers, garden hoses, etc.; However, it is not designed to be submerged in water.

Do not pressure-wash SunBriteTV: SunBriteTV will resist water exposure from normal rain, sprinklers, garden hoses, etc.; However, it is not designed to withstand pressure washers, high-pressure water jets, or hurricane-type weather.

Do not service SunBriteTV yourself: Removal of the television screen cover may expose you to high voltage or other dangerous risks. Refer all servicing to a qualified service professional. Warranty will not be honored if you service the unit yourself.

Repair: If any of the following conditions occurs, unplug the power cord, and call a qualified service professional to perform repairs:

When power cord or plug is damaged.

When objects have fallen into the product.

If unit was submerged in water or pressure-washed.

When product does not operate properly as described in the operating instructions. Do not touch the controls other than as described in the operating instructions. Improper adjustments of controls not described in the instructions can cause damage, which can require extensive repair work by a qualified technician.

When the product has been dropped or damaged.

When the product displays an abnormal condition. Any noticeable abnormality in the product indicates that the product needs servicing.

Replacement parts: In case the product needs replacement parts, make sure that the service person uses replacement parts provided by SunBriteTV. Use of unauthorized parts can result in fire, electric shock and/or other danger.

Safety checks: Upon completion of service or repair work, ask the service technician to perform safety checks to ensure that the product is in proper operating condition.

Table of Contents

Important Safety Instructions	2
Table of Contents	5
Supplied Accessories	6
TV Installation	
Choose a Location for the TV	6
Detachable Speaker Module Installation	7
Rear Panel Internal Connect Source	8
Rear Panel Connections	9
Side Panel and Front Panel Controls	17
Remote Control Guide	18
Initial Set Up	20
Adjusting On-Screen Displays	
Channel Menu	22
Picture Menu	23
Sound Menu	24
Time Menu	25
Option Menu	26
Lock Menu	27
Trouble Shooting	28
Care of SunBriteTV	29
Specifications	30
PC Timing Codes	30
Features Information and Instructions	
Internal Thermostatically-Controlled Heater	31
Programming Other Manufacturers' Universal Remote Control Devices	31
SunBriteTV Pixel Quality Policy	31
Appendix A - RS232 Control Codes	32
Appendix B - RS232 Control Cable Pinout	33

Supplied Accessories

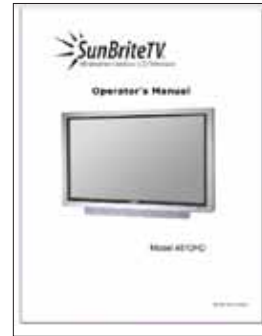
Unpacking

After unpacking the SunBriteTV television, please make sure that the following items are included in the carton and that they are in good condition. If items are damaged or missing, contact your dealer immediately.

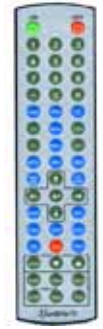
- SunBriteTV LCD Television Model 4610HD
- Remote Control with Batteries
- Operator's Manual
- Speaker Module



Model 4610HD



Operator's Manual



Water-Resistant Wireless Remote Control



Speaker Module

TV Installation - Choose a Location for the TV

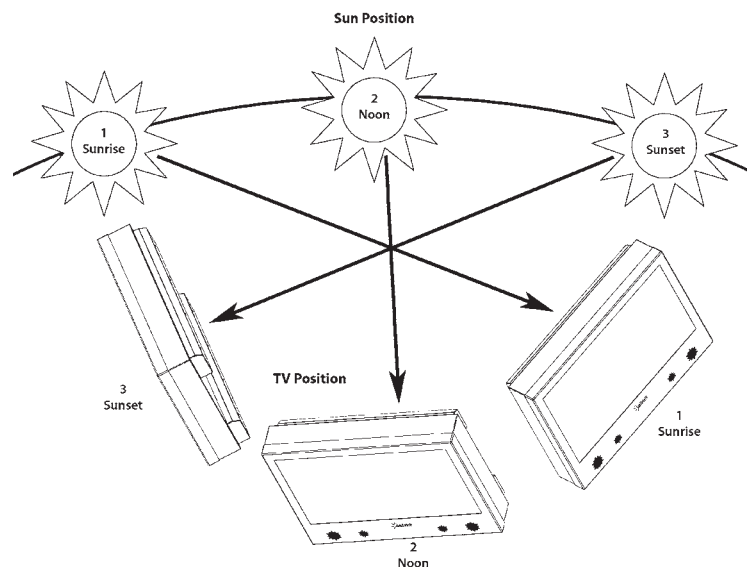
Choose a Location for the TV

Important: The TV must be installed at least 5 feet from pool, spa, or other body of water.

The TV should be installed so the screen is not facing direct sunlight, or can be easily turned away from direct sunlight.

Ideal placement is in an area where the TV is shaded by trees, landscape and/or structures, or under a patio cover or gazebo.

If the sun shines directly on the screen for long periods of time, dark areas may develop on the screen. This is a normal reaction for the LCD panel, and will not cause damage to the screen. Either turn the screen away from the sun, or apply shade to the TV, and the dark areas will quickly disappear.



TV Installation - Detachable Speaker Module Installation

Detachable Speaker Module Installation

Tools Needed: Phillips screwdriver

Note:

- If you mount the TV on the Table Stand, **the Detachable Speaker Module must be installed before you attach the Table Stand.**
- If you mount the TV to a ceiling or wall mount, it is best to install the Detachable Speaker Module after the TV has been mounted.

1. Prepare a flat work surface, free of any debris or items which may scratch the front surface of the TV.
2. Lay the TV face-down on the work surface with the bottom of the unit closest to you

WARNING: Use at least two people when transporting the TV.

3. Position the TV so that the bottom edge overhangs the table by about one inch.
4. On the bottom rim of the TV, there are four Pan Head Mounting Screws. Remove the Pan Head Mounting Screws, and set aside.

Important Note: Always replace mounting screws. Failure to do so will allow water to seep inside your TV. This can cause serious injury and can damage your TV.

5. Turn the Speaker Module with the speaker grill facing the floor, and align the Speaker Mounting Holes to the TV Mounting Holes. Replace Pan Head Mounting Screws through Speaker Mounting Holes and TV Mounting Holes. (Figure 2).

6. Screw *securely* (Figure 3).

7. Unscrew the three Thumb Screws, and pull the Connect Source Cover open (Figure 4).

8. Take the Speaker Cable from the speaker, making sure that the Speaker Cable Wire is placed over the right side of the Rubber Sealing Gasket (Figure 5), and plug it into the Speaker Connector.

10. When you close the Connect Source Cover, be sure that the Speaker Cable Wire is placed across the outside portion of the Rubber Sealing Gasket. The Speaker Cable Wire should not be placed across the bottom of the Rubber Sealing Gasket (Figure 6).

Figure 1



Pan Head Screws

Figure 2



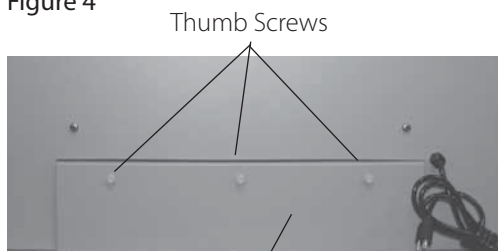
TV and Speaker Module Mounting Holes

Speaker Module

Figure 3



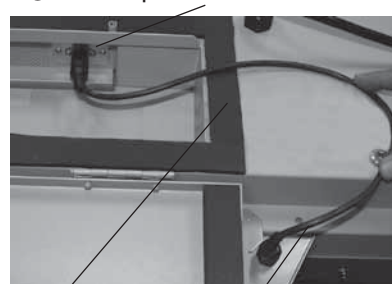
Figure 4



Thumb Screws

Connect Source Cover

Figure 5 Speaker Connector



Rubber Sealing Gasket

Speaker Cable

Figure 6



Speaker Cable Wire should not come out of this area

TV Installation – Rear Panel Internal Connect Source

Rear Panel Connections

WARNING: Do not connect the power source before making connections.

Internal Connect Source

The Internal Connect Source allows you to easily connect to the Audio, Video, S-Video, SVGA, HDMI, Audio Out, RF, RS232, and 12 VDC connectors, and the IR emitter window. The Internal Connect Source is inside the Cable Cover located on the back of the unit (Figure 1).

1. Unscrew the three gray Thumb Screws (Figure 1), and pull the cover towards you.
2. Route the cables to the proper inputs, and place the cable cords over the Rubber Sealing Gasket (Figure 2).

Note: There is an Indentation on the Rubber Sealing Gasket (on the bottom portion of the right and left sides). Make sure cable cords are not placed on the Indentation.

3. Close the cover.
4. Press firmly on the cover, and screw the Thumb Screws tightly (Figure 3).

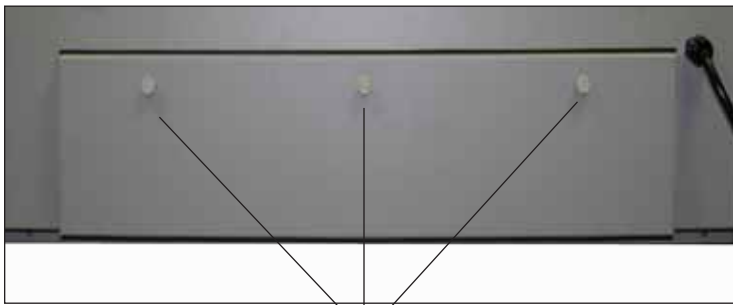


Figure 1

Thumb Screws



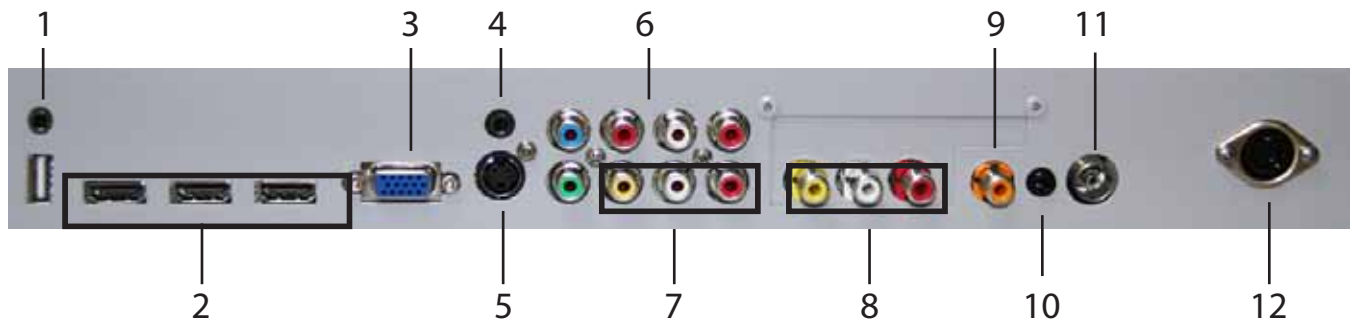
Figure 2

Indentations

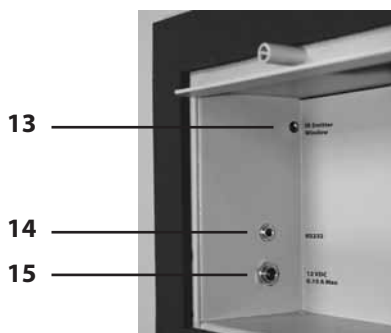


Figure 3

TV Installation – Rear Panel Connections



- 1. USB or 1/8 minijack:** This port is used for factory firmware upgrades.
- 2. HDMI (3):** HDMI connects to devices that use HDMI cable, such as Blue-ray or HD DVD player, or HD cable/satellite set-top box. This connection port receives pure digital audio and high definition signal through one single cable. This port also can accept a HDCP video device for video.
- 3. VGA:** This connection port connects to a PC for video using VGA cable. Be sure to connect your audio cable to the VGA Stereo input if you want sound out of VGA video source.
- 4. VGA Stereo Input:** This connection port is for people who want to provide audio to the TV when using a PC or DVI video device. The sources use 3.5 mini-jack audio cable.
- 5. S-Video:** - Connects to devices that use S-video cables such as a VCR, camcorder or video game console.
- 6. Component (YPbPr)** - This connection port is for DVD players or satellite/cable set-top boxes that use component cables. From left to right, connect green, blue and red for video, and then connect white for left channel audio and red for right channel audio.
- 7. AV1** - Connects to devices that use composite video such as VCR or camcorder or video game consoles. Connect the video portion with either the yellow connector or the S-Video connector. Do NOT connect both video connectors. Use the SOURCE button to select AV1 (CVBS) on your MAIN SOURCE if you are using the yellow plug for video, use the SOURCE button to select AV1 (S-Video) on your MAIN Source if you are using the S-Video connector to view this connection.
- 8. AV2 (option)**
- 9. SPDIF Audio Out** - This connection is used for connecting a headphone or amplifier to the TV
- 10. Analog Audio Out** - This connection is used to connect headphones, stereo receivers and amplified speakers.



11. TV Tuner: This connection is for digital or analog cable without the cable box or over-the-airwave antennas. The tuner is a hybrid tuner that tunes to both analog and digital channels. This connection uses coaxial RF cable.

12. Speaker Module Connector: This port is for the SunBriteTV Detachable Speaker Module only.

13. IR Window: The Internal Infrared (IR) Control Window allows the TV to be controlled from a remote system using IR commands.

14. RS232 - The RS232 connection allows the TV to be controlled from a remote system using RS232 commands. (See Appendix A of this manual for a list of RS232 control commands and Appendix B for a Control Cable Pinout Diagram.)

15. 12 VDC - This port is for the SunBriteTV FM Radio connector only.

Emitter Window:

Figure 15 shows an Emitter* installed. One end of the Emitter is to be mounted in front of the IR Emitter Window. The other end is to be connected to an appropriate control block*.

* Neither the emitter or control block are supplied by SunBriteTV. See instructions that come with your IR Emitter and control block to determine how to make the connection.

Important note: SunBriteTV recommends using a high-output IR Emitter, such as Xantech 282M.

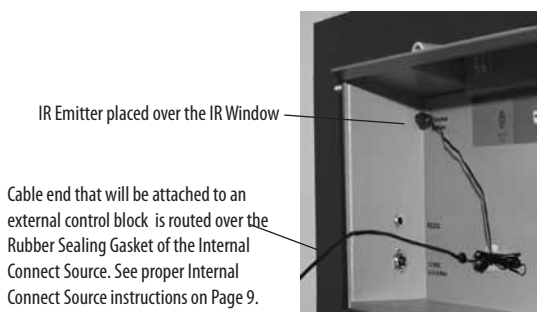






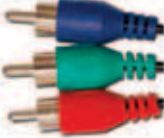





Figure 15




TV Installation – Rear Panel Connections

Connection Descriptions:

Port Quality & Name	Port Picture	Cable Used & Resolution	Devices that use this Port
Best HDMI 1, 2, 3 (Digital HD Capable)		HDMI 1080p, 1080i, 720p, 480p, 480i	Blu-ray DVD Player, HD-DVD Player, HD Cable or HD Satellite Set-top Box, HDCP devices, PC
Best/Fair TV Tuner (Digital HD Capable)		Coaxial RF 1080i, 720p, 480p, 480i	Antenna or Digital Cable with out the cable box
Best VGA (HD Capable)		VGA 1920x1080 or lower	PC or MAC with VGA connection
Better COMPONENT 1 & 2 (HD Capable)		YPBPR 1080p, 1080i, 720p, 480p, 480i	DVD Player, Video Game Console, High Definition Cable or Satellite Set-top Box
Good AV 1, 2 (Non-HD)		S-Video 480i only	Non High Definition Cable or Satellite Set-top Box, S-Video VCR
Fair AV 1 & 2 (Non-HD)		Composite 480i only	Non High Definition Cable or Satellite Set-top Box, VCR, Old Game Console, Camcorder

Cable Descriptions:

Cable Name	Cable Picture
HDMI	
Coaxial RF	
VGA	
YPBPR	
S-Video	
Composite	
3.5 mm Mini-jack	
RCA Audio	
SPDIF	

Port Quality, Type & Name	Port Picture	Cable Used & Resolution	Devices that use this Port
Good VGA STEREO INPUT (Audio)		3.5mm mini-jack	HDCP devices, PC, MAC
Best SPDIF (Digital Audio)		SPDIF	Receiver with Digital Surround Sound Decoding
Not Available		Service Port	This port is for SBTV technicians only.

TV Installation – Rear Panel Connections/Connection Diagrams

Switching Sources for Ports:

Model 4610HD offers several options when connecting your devices to the TV. The chart below will help you understand which source you switch to for each of the ports.

Port Picture	Cable Used	Source Name to Switch to
	HDMI or HDMI-DVI	HDMI 1 - 3
	COAXIAL RF	TV (CABLE / AIR)
	VGA	VGA
	YPBPR	YPBPR (Component)
	S-VIDEO	AV 1 (S-VIDEO)
	COMPOSITE	AV 1 (CBVS) or AV 2 (CVBS)

CONNECTING TO AN ANTENNA



Connecting to Digital Cable without Cable Box or Antenna:

Note: For ease of install, SunBriteTV has included a Push-on Coaxial Adapter.



1. Make sure the power to the TV is turned off.
- 2-a. Connect the Coaxial RF cable from your antenna or digital cable to the Push-on Coaxial Adapter that was shipped with the TV.
- 2-b. Slip on the Push-on Coaxial Adapter and Coax onto the NTSC/ATSC port on the back of the TV.
3. Turn on the TV.
4. Select TV Air/Cable in the Menu/TV /Tuner mode.
5. Use the On-Screen Display to scan for channels (Setup/TV/Channel Scan)

Please Note :

1. Not all broadcasts are in High Definition (HD). Please refer to your local broadcasting stations for more information.
2. The TV's tuner is designed for HDTV therefore requires a stronger signal than normal TVs. If you cannot achieve that signal level with your antenna or cable, your 4610HD might lose picture or sound.

TV Installation – Rear Panel Connection Diagrams

CONNECTING TO A DVD PLAYER



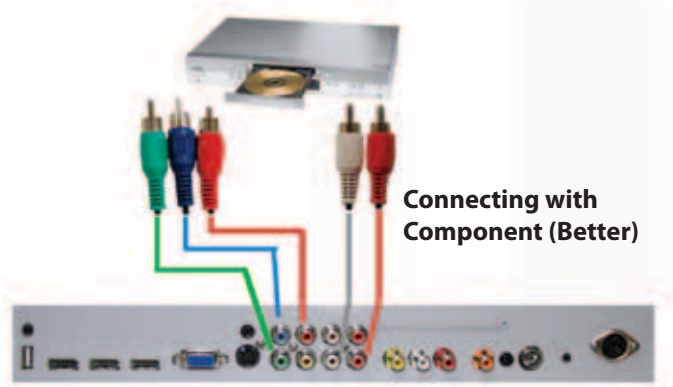
1. Make sure the power of the TV and your DVD player is turned off.
2. Connect a HDMI cable to the HDMI port of your DVD player and the other end to the HDMI port off the back of your TV.
3. Turn on the TV and your DVD player.
4. Use the remote control's source button or the source button on the TV to switch to HDMI.

Please Note :

Refer to the DVD player's manual to make sure the DVD player is configured to output correctly to the TV.

Please Note :

1. Refer to the DVD player's manual to make sure the DVD player is configured to output correctly to the TV.
2. This TV does not decode Bit stream digital audio, so make sure the DVD is setup for PCM digital audio through HDMI.
3. If HDMI 1 is occupied, use HDMI 2 as your connection port.



1. Make sure the power of TV and your DVD player is turned off.
2. With a Component Cable, connect the green connector to the DVD player and Component 1's green connector port on the TV.
3. Connect the blue color connector to your DVD player and Component 1's blue connector port on the TV.
4. Connect the red color connector to both your DVD player and Component 1's red connector port on the TV.
5. With an RCA Audio Cable, connect the white color connector to both your DVD player and Component 1's white connector port on the TV.
6. Connect the red color connector to both your DVD player and Component 1's red connector port on the TV.
7. Turn on the TV and your DVD player.
8. Use the remote control's source button or the source button on the TV to switch to YPbPr.

Please Note :

1. Refer to the DVD player's manual to make sure the DVD player is configured to output correctly to the TV.
2. This TV will turn off automatically if there's no signal present for more than 15 minutes.

TV Installation – Rear Panel Connection Diagrams

CONNECTING TO A DVD PLAYER (Continued)

Connecting with S-Video (Fair)



1. Make sure the power of the TV and your DVD player is turned off.
2. Obtain an S-Video Cable. Connect the S-Video connector to both your DVD player and Composite's S-Video connector port off the back of your MODEL 4610HD.
3. Obtain a RCA Audio Cable. Connect the white color connector to both your DVD player and Composite's white connector port off the back of your MODEL 4610HD.
4. Connect the red color connector to both your DVD player and Composite's red connector port off the back of your TV.
5. Turn on the TV and your DVD player.
6. Use the remote control's source button or the source button on the right side of the TV to switch to AV1 (S-Video).

Please note:

1. If AV 1 is already occupied, use AV2, as your connection port, and switch source to AV 2 (S-Video)
2. Reference the DVD player's manual to make sure the DVD player is configured to output correctly to the TV.
3. This TV will turn off automatically if there's no signal present for more than 15 minutes.

Connecting with Composite (Fair)



1. Make sure the power of the TV and your DVD player is turned off.
2. Obtain a Yellow Video Cable. Connect the Yellow Video connector to both your DVD player and Composite's Yellow Video connector port off the back of your TV.
3. Obtain a RCA Audio Cable. Connect the white color connector to both your DVD player and Composite's white connector port off the back of your TV.
4. Connect the red color connector to both your DVD player and Composite's red connector port off the back of your TV.
5. Turn on the TV and your DVD player.
6. Use the remote control's source button or the source button on the right side of the TV to switch to AV1 (CVBS).

TV Installation – Rear Panel Connection Diagrams

CONNECTING TO A SATELLITE OR CABLE SET-TOP BOX

Connecting with HDMI (Best)

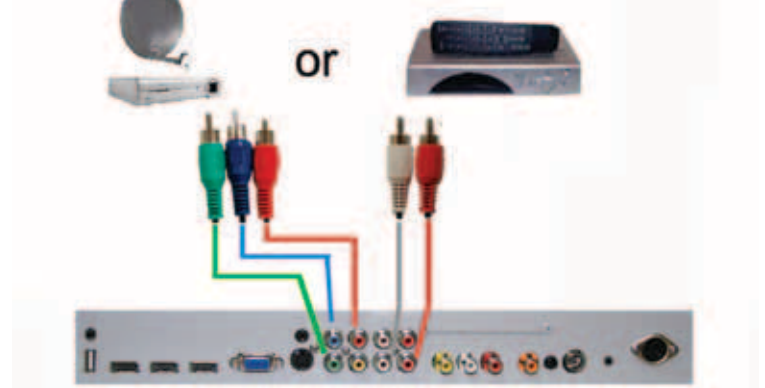


1. Make sure the power of the TV and your set-top box is turned off.
2. Connect a HDMI cable to the HDMI output of your set-top box and the other end to the HDMI port off the back of your TV.
3. Turn on the TV and your set-top box.
4. Use the remote control's source button or the source button on the right side of the TV to switch to HDMI 1.

Please Note :

1. Refer to the set-top box's manual, to make sure the set-top box is configured to output correctly to the TV.
2. If HDMI 1 is already occupied, use HDMI 1 as your connection port and switch source to HDMI 2.
3. SunBriteTV's MODEL 4610HD supports SONY's universal remote code. Please look up SONY's codes in your universal remote's hand book.
4. This TV will turn off automatically if there's no signal present for more than 15 minutes.

Connecting with Component (Better)



1. Make sure the power to the TV and set-top box is turned off.
2. Obtain a Component Cable. Connect the green color connector to both your set-top box and Component 1's green connector port off the back of your TV.
3. Connect the blue color connector to both your set-top box and Component 1's blue connector port off the back of your TV.
4. Connect the red color connector to both your set-top box and Component 1's red connector port off the back of your TV.
5. Obtain a RCA Audio Cable. Connect the white color connector to both your set-top box and Component 1's white connector port off the back of your TV to the right side of your green, blue, red component connection.
6. Connect the red color connector to both your set-top box and Component 1's red connector port off the back of your TV to the right side of your green, blue, red component connection.
7. Turn on the TV and your set-top box.
8. Use the remote control's source button or the source button on the TV to switch to YPbPr.

Please Note :

1. Please refer to the set-top box's manual to make sure the set-top box is configured to output correctly to the TV.
2. This model supports SONY's universal remote code. Please look up SONY's codes in your universal remote's hand book.
3. This TV will turn off automatically if there's no signal present for more than 15 minutes.

TV Installation – Rear Panel Connection Diagrams

CONNECTING TO A SATELLITE OR CABLE SET-TOP BOX (Continued)

Connecting with S-Video (Fair)



1. Make sure the power of the TV and your DVD player is turned off.
2. Obtain an S-Video Cable. Connect the S-Video connector to both your DVD player and Composite's S-Video connector port off the back of your MODEL 4610HD.
3. Obtain a RCA Audio Cable. Connect the white color connector to both your DVD player and Composite's white connector port off the back of your MODEL 4610HD.
4. Connect the red color connector to both your DVD player and Composite's red connector port off the back of your TV.
5. Turn on the TV and your DVD player.
6. Use the remote control's source button or the source button on the right side of the TV to switch to AV1 (S-Video).

Please Note :

1. If AV 1 is already occupied, use AV 2 as your connection port and switch source to AV 2 (S-Video).
2. Refer to the set-top box's manual to make sure the set-top box is configured to output correctly to the TV.
3. SunBriteTV's MODEL 4610HD supports SONY's universal remote code. Please look up SONY's codes in your universal remote's hand book.
4. This TV will turn off automatically if there's no signal present for more than 15 minutes.

Connecting with Composite (Fair)



1. Make sure the power of the TV and your DVD player is turned off.
2. Obtain a Yellow Video Cable. Connect the Yellow Video connector to both your DVD player and Composite's Yellow Video connector port off the back of your TV.
3. Obtain a RCA Audio Cable. Connect the white color connector to both your DVD player and Composite's white connector port off the back of your TV.
4. Connect the red color connector to both your DVD player and Composite's red connector port off the back of your TV.
5. Turn on the TV and your DVD player.
6. Use the remote control's source button or the source button on the right side of the TV to switch to AV1 (CVBS).

Please Note :

1. If AV 1 is already occupied, use AV 2 as your connection port and switch source to AV 2 (S-Video).
2. Refer to the set-top box's manual to make sure the set-top box is configured to output correctly to the TV.
3. SunBriteTV's MODEL 4610HD supports SONY's universal remote code. Please look up SONY's codes in your universal remote's hand book.
4. This TV will turn off automatically if there's no signal present for more than 15 minutes.

TV Installation – Rear Panel Connection Diagrams

CONNECTING TO AN EXTERNAL AMPLIFIER OR AMPLIFIED SPEAKERS

Connecting with SPDIF Digital (Best)



1. Make sure the power of the TV and your receiver is turned off.
2. Obtain a Coaxial SPDIF cable, connect it to your receiver's coaxial SPDIF digital input and the Coaxial SPDIF connection on the LINE OUT port off the back of the TV.
3. Turn on the TV and your receiver.

Please Note :

1. If you want pure digital stream for your receiver to decode, you must also configure the TV's OSD Sound->Digital Audio Out function. Make sure the option is on Bit Stream.
2. If your receiver is making static noises when receiving Bit Stream, you must use the PCM option instead.
3. Refer to the receiver's manual to make sure the receiver is configured to receive signals correctly from the TV

Connecting with RCA Audio Analog (Good)



1. Make sure the power of the TV and your receiver is turned off.
2. Obtain a 3.5mm stereo/audio cable (if your amplifier audio connection requires RCA audio out jacks you will need to obtain an 1/8" Stereo Mini Plug to RCA adapter cable). Connect it to your receiver's audio input connection and the 3.5mm stereo/audio connection on the Analog Audio port on the back of the TV.
3. Turn on the TV and your receiver.

Please Note :

1. If you want pure digital stream for your receiver to decode, you must also configure the TV's OSD Sound->Digital Audio Out function. Make sure the option is on Bit Stream.
2. If your receiver is making static noises when receiving Bit Stream, you must use the PCM option instead.
3. Refer to the receiver's manual to make sure the receiver is configured to receive signals correctly from the TV

CONNECTING TO A PC

Connecting with RCA Audio Analog



1. Make sure the power of the TV and your PC is turned off.
2. Obtain a 15-pin D-Sub VGA cable, connect to the VGA output of your PC and the other end to the VGA port off the back of your TV.
3. Obtain a 3.5 mm Mini-jack, connect to the audio out of your PC and the other end to the VGA Stereo Input port.
4. Turn on the power of the TV and your PC.
5. Use the remote control's source button or the source button the TV to switch to VGA.

Please Note :

1. For the best results, please set your PC resolution to 1920 x 1080 at 60 Hz. Refer to the PC or graphic card's manual for further instructions on how to set your resolution and refresh rate.
2. Refer to your PC manual for video output requirements of the video card.
3. The VGA port of the TV features a power saving mode which will automatically turn off the TV if there is no signal provided for more than 15 minutes.

TV Installation--Rear Panel Connection Diagrams

Connecting the Power Cord

WARNING:

TV AND GFCI RECEPTACLE MUST BE INSTALLED AT LEAST 1.6 METERS AWAY FROM STANDING WATER , SUCH AS (BUT NOT LIMITED TO) A POOL OR SPA.

Connect the power cord after you have made connections to your video equipment.



Connect the power cord to a GFCI-protected outlet (safety-switch or trip-switch) with "in-use" waterproof cover.

Warning: TV must be installed at least 1.6 meters away from standing water, such as (but not limited to) a pool or spa.

Side Panel



Power	Turns TV on/off.
Input	Press to change the input sources.
Menu	Displays the On-Screen Display (OSD) menu. In OSD menu, press key to return to pre-phase.
CH+/CH-	Adjusts channels. In OSD menu, both keys are used to navigate within the menu.
Vol+ /Vol-	Adjusts volume. In OSD menu, both keys are used to navigate within menu. Vol+ is used to select the highlighted options.

Front Panel



IR Sensor

Remote Control Guide



ON – Powers the TV On.

OFF – Powers the TV Off.

0~9 – Sets the channels.

Dash (-) – Inserts the dash for selecting digital channels directly.

R – Returns to the previous channel.

FREEZE – Freezes the TV picture. **CC** – Cycles between different closed captioning modes.

SLEEP – Sets the Sleep timer.

CC- Selects Closed Caption.

V+ – Functions the Volume Up and Menu Right.

V- – Functions the Volume Down and Menu Left.

MUTE – Mutes the TV's Audio.

MENU – Opens / Exits the TV menu.

CH+ – Functions the Channel Up and Menu Up.

CH- – Functions the Channel Down and Menu Down.

MTS – Selects stereo, mono, or second audio programming.

SRS – Sets Surround Sound.

DNR – Enables the Digital Noise Reduction on the TV.

ADD/Del – Adds or deletes the current channel.

CH Lock – Locks the current channel you are on, so that kids cannot view the locked channel unless unlocked by a password. You will also need to input a password when locking the channel.

↑ / ↓ / ← / → / – Allow you to navigate inside the OSD menu. They also function as CH+/- for digital channels in the tuner.

↵ (Enter) – Allows you to select functions inside the OSD menu, acts as the Enter button for OSD menu for changing channels.

SOUND – Selects various preset sound settings.

EXIT – Allows you to quit from the OSD menu..

PICTURE – Selects various preset picture settings.

GUIDE – Opens the current digital channel information guide.

SOURCE – Cycles between different inputs of the TV.

INFO – Shows current channel information, display input and resolution.

SHIFT – Used with the 0-9 numeric pad to select inputs.

ASPECT – Changes the TV between different display modes.

FAVORITE ▲ / ▼ – Changes the channel up or down from you Favorite channel list.

FAVORITE ADD / DEL – Adds or deletes the current channel from the favorites channel list.

Picture In Picture/Picture On Picture (PIP and POP) Functions are not available on this TV.

Remote Control Guide



This remote control follows Sony's TV remote codes with discrete on/off and input select.
Direct TV code is 10,000

About the Water-Resistant Remote Control

The SunBriteTV® Water-Resistant Remote Controller is engineered to give you many years of service.

"Water-resistant" means that the remote control can be in water for short periods of time without damaging the internal workings of the unit. It can be left in the rain, and even dropped in water, as long as it is retrieved quickly.
The remote control should not be left floating in water.

The functionality of the remote control is under warranty for one year. If the remote control malfunctions within the one-year warranty period, replace the batteries with new long-life alkaline batteries.

If the problem is not solved with new batteries, contact the SunBriteTV Customer Support Team. SunBriteTV will repair or replace the remote control at SunBriteTV's option.

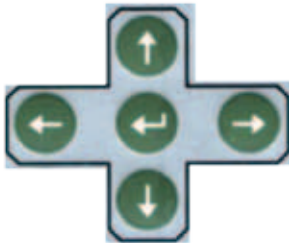
If you have a warranty claim, contact the SunBriteTV Customer Support Team for further instructions.








866.357.8688
www.sunbritev.com

On-Screen Display Controls

Via Remote Control

Use the buttons below to adjust the On Screen Display from the Remote Control.



-  – This button functions as up direction in the OSD.
-  – This button functions as down direction in the OSD.
-  – This button functions as left direction in the OSD.
-  – This button functions as right direction in the OSD.
-  – This button changes the channel in conjunction with the number pad and also functions as enter for selecting options in the OSD.
-  This button opens the OSD and also exits the OSD by going to the previous level of the OSD.
-  This button exits the OSD entirely.

Via the TV's Side Panel Buttons

Use the buttons below to adjust the On Screen Display from the TV's Side Panel Buttons.



- MENU** – This button opens the OSD.
- CH(+)** – This button changes the channel to a higher number and also functions as up direction in the OSD.
- CH(-)** – This button changes the channel to a lower number and also functions as down direction in the OSD.
- VOL(+)** – This button decreases the volume and functions as left direction in the OSD.
- VOL(-)** – This button decreases the volume and functions as right direction in the OSD.

Initial TV Setup

Initial Setup

When the TV is turned on, you may be presented with an initial Setup screen that will allow you to select your Language, Country and Tuner Channel scan.

(In the event the Initial Set-up screen is not presented when you turn on the TV, you can manually chose these options. To set the Language screen, Press the Menu button and scroll to the OSD Language.

To set the Country and Tuner Channel Scan, refer to the Channel Menu instructions (AutoTune Option) on Page 22.)

Language Setup:

Using the ▲▼ or ◀▶ buttons, scroll to the Language of your choice, press OK and you will automatically be taken to the Country Screen.



Country Setup: Using the ▲▼ or ◀▶ buttons, scroll to the Country of your choice, press OK and you will automatically be taken to the Tuner Channel Screen.

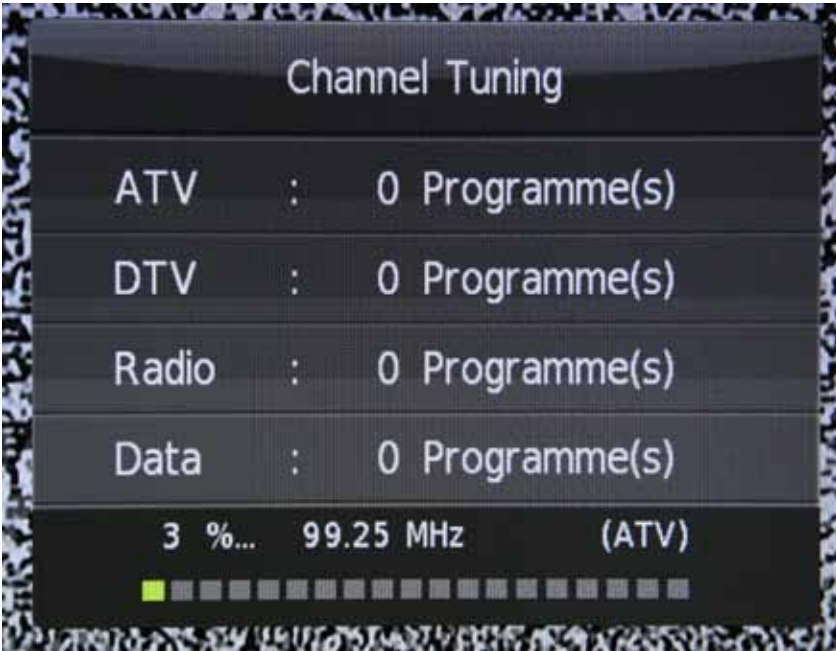


Initial TV Setup

Channel Tuner Setup:

The Channel Menu is available only when the Digital TV or Analog TV source is selected. (Using the source button, choose the ATV or DTV input button.)

The TV will now auto scan and learn the available channels. This process may take up to 15 minutes to complete.



On-Screen Display Menu - Channel Menu

TV MODE

Press **Menu** button on the remote control to show **Channel, Picture, Sound, Time, Option, Lock** menu.

Press **OK** button to select specific submenu and the adjustable value. In the submenu, press **▲▼** or **◀▶** button to select menu item.

Channel Menu

The Channel Menu is available only when the Digital TV or Analog TV source is selected.



Auto Tuning

Press **▲▼** button to select **Auto Tuning**, and then press **OK** button to choose ATV/DTV/ATV+DTV with **▲▼** button and press **▲▼** or **◀▶** button to select country.

DTV Manual Tuning

Press **▲▼** button to select **DTV Manual Tuning**, then press the **OK** button. Press **◀▶** button to select channel number, or press number keys to select channel number, and then press **OK** to begin to search channel.

ATV Manual Tuning

Press **▲▼** button to select **ATV Manual Tuning**, and then press the **OK** button then press **◀▶** button to select. Press **▲▼** or **▶** button to select specific submenu and the adjustable value.

Program Edit

Press **▲▼** button to select **Program Edit**, and then press **OK** button to enter menu.

Signal Information

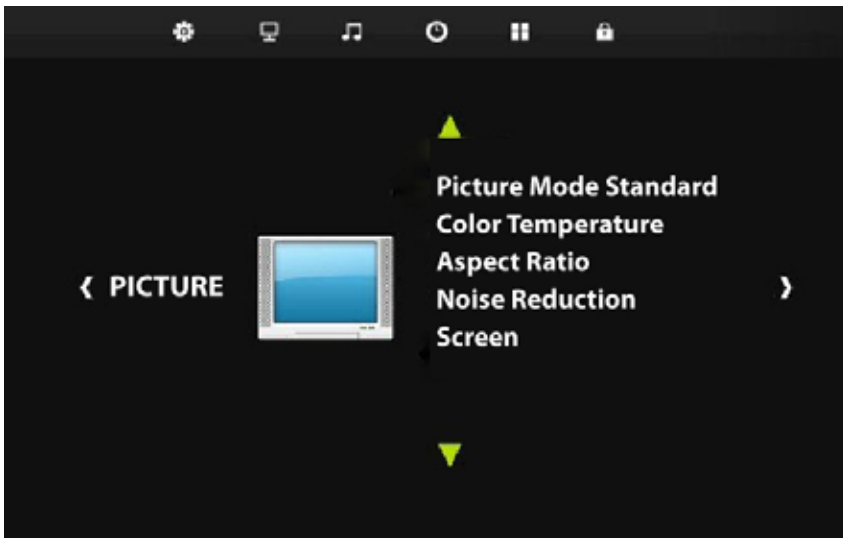
Press **▲▼** button to select **Signal Information**, and then press **OK** button to see Signal Information

LCN Sorting

Press **▲▼** button to select **LCN Sorting**, and then press **OK** button to set sort on/off

Adjusting On-Screen Displays – Picture Menu

Picture Menu



Press **Menu** then use the ◀▶ to select the picture menu.
Press ▲▼ to select **Picture** mode option and then OK button to select.

Picture Mode

Press ◀▶ button to select standard/mild/dynamic preset picture settings. Select user option to select a custom contrast, brightness, color and sharpness settings.

Color Temperature

Press ◀▶ button to select cool, medium, and warm color preset settings. Select user option to select a custom red, green, and blue setting.

Aspect Ratio

Press ▲▼ to select **Aspect Ratio**, and then OK button to enter.

Noise Reduction

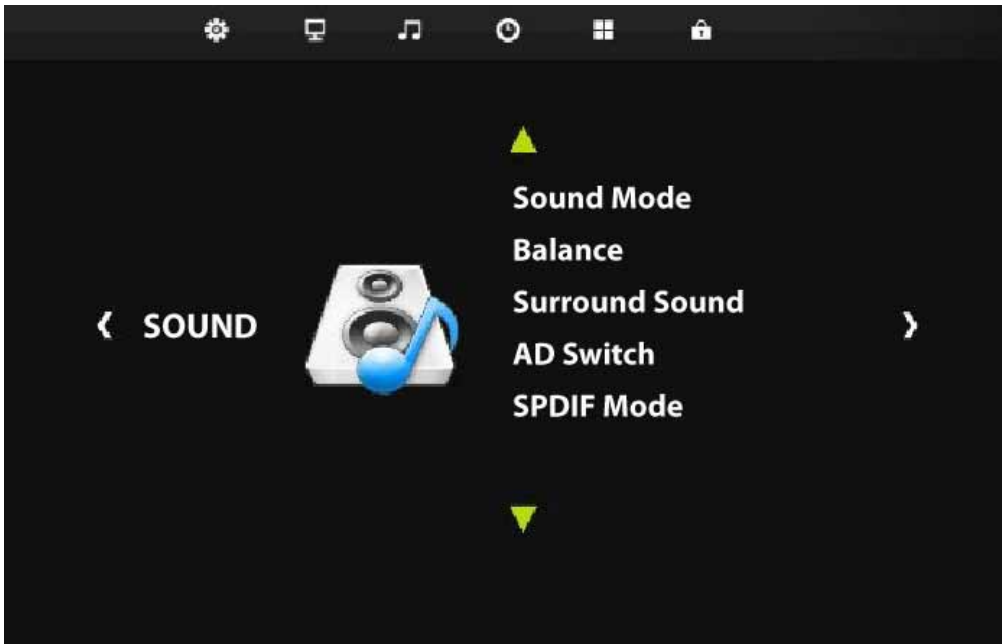
Press ▲▼ to select **Noise Reduction** mode, and then OK to enter submenu. You can select off/low/middle/high/default by pressing the ▲▼ button.

Screen (this menu is only available when PC-RGB is selected)

Press ▲▼ to select **Screen mode**, and then press OK to enter submenu in PC mode. Select this option to auto adjust the RGB timing or to fine tune the display.

Adjusting On-Screen Displays – Sound Menu

Sound Menu



Sound Mode

Press ▲▼ to select Sound Mode, and then OK button, press ◀▶ buttons to select sound presets standard, music, movie, sports. Select user to select custom sound settings.

Balance

Press ▲▼ to select Balance, and OK button to enter submenu, press ◀▶ buttons to adjust balance value.

Surround Sound

Press ▲▼ to select Surround Sound, and then OK button to enter submenu, then press ▲▼ buttons to select off/surround/SRS Tru-surround XT mode.

AD Switch

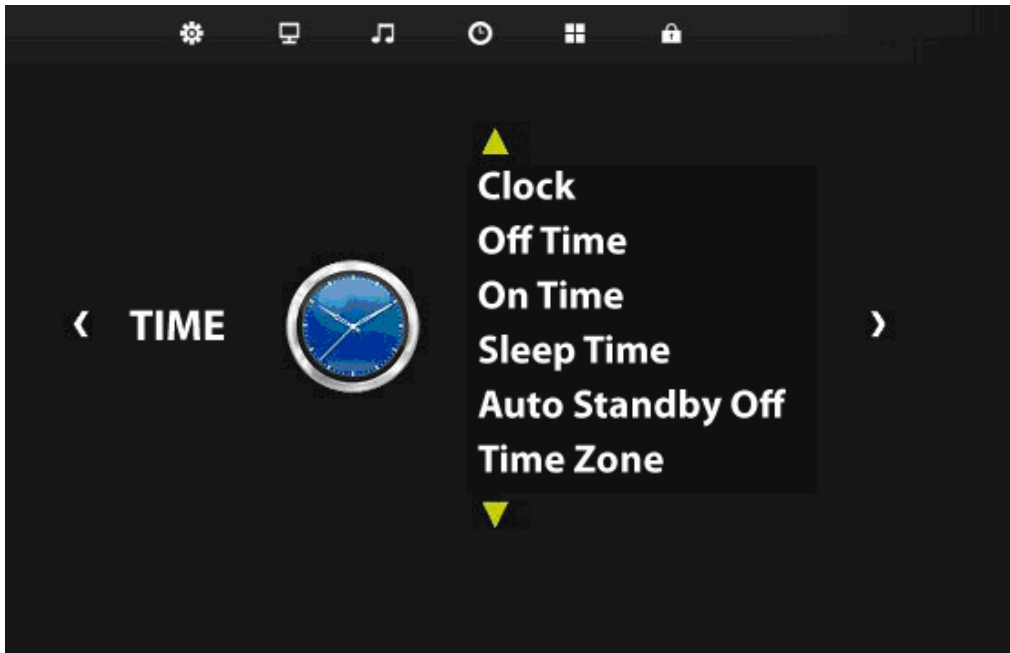
Press ▲▼ to select AD Switch, and then OK button to select on/ off, and you can adjust AD volume value by pressing ◀▶ buttons when AD switch is set to on.

SPDIF MODE

Press ▲▼ to select SPDIF mode, and then OK button to select PCM/AUTO mode

Adjusting On-Screen Displays – Time Menu

Time Menu



Clock

Clock is set using Digital TV transmission.

Off Time

Press ▲▼ to select **Off Time**, and then OK button to enter the submenu, press ◀▶ to select off/once/everyday/Mon-Sat etc. And you can adjust hour or minute by pressing ◀▶ buttons.

On Time

Press ▲▼ to select **On Time**, and then OK button to enter the submenu, press ◀▶ to select off/once/everyday/Mon-Sat etc. And you can adjust hour / minute / source /channel / volume by pressing ◀▶ button.

Sleep Timer

Press ▲▼ to select **Sleep Timer**, and then OK button to enter submenu, and press ▲▼ to select the sleep timer type .

Auto Standby off

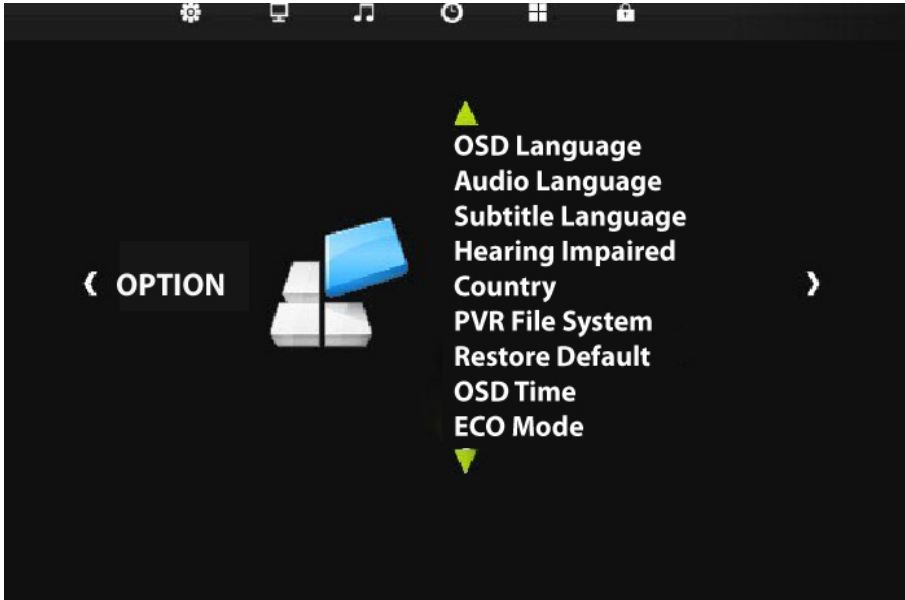
Press ▲▼ to select **Auto Standby off** and then OK button to set and select 3h/4h etc

Time Zone

Press ▲▼ to select **Time Zone**, and then OK button to enter submenu, and press ▲▼ or ◀▶ to adjust the time zone.

Adjusting On-Screen Displays – Option Menu

Option Menu



OSD Language

Press ▲▼ to select OSD Language, and then OK button. Press ▲▼ or ◀▶ button to choose language choices.

Audio Language

Press ▲▼ to select Audio Language, and then OK button to enter submenu, and then press ◀▶ to select primary or secondary type.

Subtitle Language

Press ▲▼ to select Subtitle Language, and then OK button to select prime or second.

Hearing impaired

Press ▲▼ to select Hearing impaired, and then OK button to select on/off

Country

Press ▲▼ to select Country, and then OK button to select country

PVR File system

Press ▲▼ to select PVR File system, and then OK button to select Disk C and press ▲▼ to adjust.

Restore Default

Press ▲▼ to select Restore Factory Default, and then OK button to select sure or not.

OSD Time

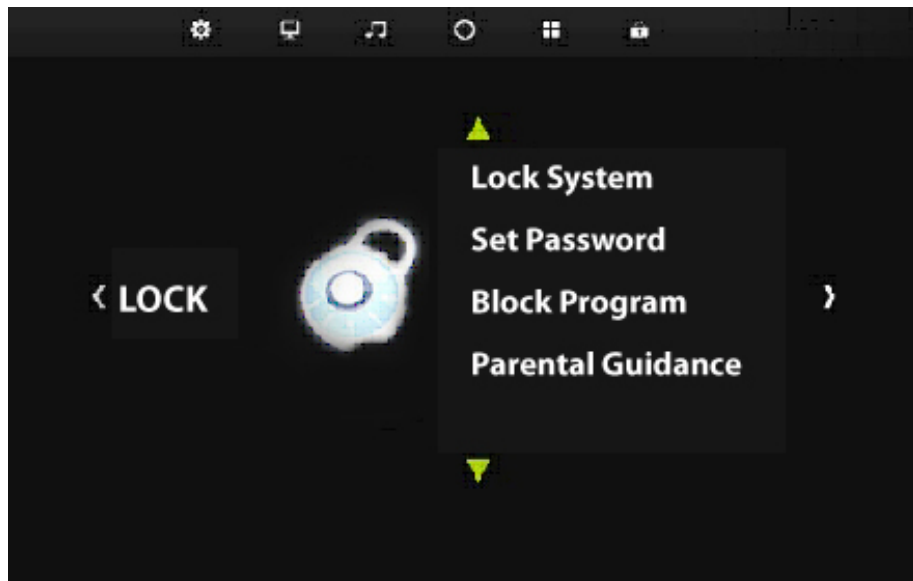
Press ▲▼ to select OSD Time, and then OK button to select 30s/60s etc.

ECO Mode (Backlight Brightness)

Press ▲▼ to select ECO Mode and press ▲▼ button to select high/middle/low mode

Adjusting On-Screen Displays – Lock Menu

Lock Menu



Press ▲▼ to select Lock System, and then OK button to select on/off to open and close the lock function.

Set Password

Press ▲▼ to select Set Password, and then OK button to input old password "0000" and set new password

Block Program

Press ▲▼ to select Block Program, and then OK button to enter the submenu and then green button to choose lock/ unlock mode.

Parental Guidance

Press ▲▼ to select Parental Guidance, and then OK button to select off/4/5 etc.

TROUBLESHOOTING

The following table contains the common problems and the solutions to these problems. Please check this list before you contact the technicians.

Problems	Solutions
NO PICTURE	Connect power cord correctly.
	Turn on power.
	Connect video cable correctly.
	Select the input signal source with proper cable connection with the source button.
ABNORMAL COLORS	Match the colors on the cables to the ports off the back of the television. I.E. red cable to red colored port.
PICTURE IS TOO DARK	Adjust your contrast, brightness and lamp settings from the OSD Menu.
AUDIO ONLY NO PICTURE	Make sure you have connected both your video and audio cables. The TV's tuner signal must not be lower than 65 %.
PICTURE ONLY NO AUDIO	Make sure the audio cable is connected.
	Readjust your volume via the remote control.
	The TV's tuner signal must not be lower than 65 %.
REMOTE CONTROL DOES NOT WORK	Turn off the TV, unplug it from the socket. Remove the batteries out of the remote for 30 minutes. Press the remote buttons and the power button randomly for a good 2 seconds, and then reinstall the batteries. Try the remote to see if it works. The TV's remote sensor is also housed in the same place as the power indicator light. Please make sure there is line of sight from the remote control's front sensor to the remote sensor of the TV.
	The TV's tuner signal must not be lower than 65 %. Change the direction of your antenna and rescan your channels. If you have cable call up your cable company and ask about signal strength of your local cable.
CANNOT RECEIVE SUFFICIENT CHANNELS THROUGH THE TUNER	Please adjust your picture setup and make sure the saturation and the RGB are not turned all the way down. The TV's tuner signal must not be lower than 65 %. Check your signal.
NO COLOR	The TV's tuner signal must not be lower than 65 %. Change the direction of your antenna and rescan your channels. If you have cable call up your cable company and ask about signal strength of your local cable.
WEAK SIGNAL OR NO PROGRAM SYMBOL ON SCREEN	The TV's tuner signal must not be lower than 65 %. Change the direction of your antenna and rescan your channels. If you have cable call up your cable company and ask about signal strength of your local cable.
TV'S UNIVERSAL REMOTE CODE	This television follows SONY's universal remote code. To find the actual code you must read through your own universal remote's guide book.

Problems	Solutions
TV CHANNELS ARE BLOCKED	Check your auto lock function's settings inside the OSD. You may have locked up some channels but forgot about them.
UNIVERSAL REMOTE CODE	This TV follows SONY's universal remote code. Please check your hand book for SONY's codes then apply them.
THE TV TURNS ON OR OFF SLOWLY AND THE SCREEN SHOWS UP SLOWLY	This TV is a High Definition liquid crystal display panel TV. It requires a few more seconds than normal TVs to power up and show the picture.
NO SOUND ON PC	Make sure you have a 3.5 mm mini-jack cable connected from your pc's sound output to the TV's VGA STEREO INPUT.
HDCP VIDEO SAYS NO HDCP SUPPORT	Reboot your HDCP video device but turning them off and unplugging the power cord. Wait up to 8 minutes to plug the power back in to see if it works or not.
HDCP VIDEO HAS NO AUDIO	Make sure you have a 3.5 mm mini-jack cable connected from your HDCP video device's sound output to the TV's VGA STEREO INPUT. If your HDCP video device uses RCA AUDIO jacks, you'll need to obtain a RCA audio converted into 3.5 mm mini-jack cable.
CANNOT GET 1920X1080 ON PC VGA	Make sure the TV is recognized as plug and play monitor. Try updating your video card's drivers as well. If that does not help, most likely you'll need to upgrade your video card to a newer one.
PICTURE IS DISTORTED OR HAS ABNORMAL SOUND	This might be from interference from large electrical appliances, cars, motorcycles, or fluorescent lights. If the TV is close to the wall, try moving the TV to another room in your house to see if the problem still occurs.
PICTURE DOES NOT COVER THE ENTIRE SCREEN	If you're using HDMI or a TV digital channel make sure you use the ASPECT button to switch to 16:9 format. If you are using VGA, use the AUTO ADJUST function to adjust to the screen. Please Note : If you are using regular analog TV, AV, or component in 480i resolution, use the ASPECT button to switch to 16:9 in order to fill up the screen. Please Note : This note this feature will distort the picture.
	For best image quality, view HD widescreen programs where possible. If HD content is not available view "Standard Definition" from a digital source. Standard, analog TV will always be noticeable inferior to HD because your LCD HDTV has video that is many times better than old TV's and so you can see interference and deficiencies you did not KNOW you had.
PICTURE QUALITY IS HORRIBLE!!	Your LCD HDTV is manufactured using an extremely high level of precision technology, however, sometimes some pixels of your LCD HDTV may not display. Pixels defects within industry specifications are inherent to this type of product and do not constitute a defective product.
PICTURE HAS PIXELS THAT ARE ALWAYS DISPLAYING THE SAME COLOR	Your LCD HDTV syncs time automatically according to your local TV channel. This function only works while the TV's tuner is connected to an ANTENNA.
I CANNOT CHANGE THE TIME MANUALLY	You have turned on closed captioning and are using TEXT1 – TEXT4. Change the setting to CC1 or turn off closed captioning and the box will disappear.

Problems	Solutions
SWITCHING A CHANNEL OR SOURCE CHANGES THE VOLUME	Different channels and inputs will sometimes have this effect because the channel signal's own volume is already loud. There is no way remove this completely. The TV has an AUTO VOLUME LEVEL function that can combat this type of effect. Please make sure that function is turned on.
THERE IS NOISE OR TRASH PIXELS ON THE SCREEN	When your LCD HDTV's resolution is higher than the digital channel's broadcast resolution, the signal is up-converted to match your TV's resolution. Up-converting can cause this type of effect.
TIPS FOR HIGH DEFINITION USERS	The LCD HDTV is an ideal platform for viewing High Definition Content. The best image quality can be achieved by HDMI, YPbPr (Component), then VGA. However, due to variances in broadcast practices, it is possible some image distortions can occur.
TIPS FOR LETTERBOX CONTENT USERS	Letterboxed (Widescreen) versions of DVD movies are most commonly formatted for standard 4:3 TVs. The 55" LCD HDTV has the capability of expanding this content so the entire screen is filled at the expense of the image proportion. To use this function press the aspect button on the remote control and cycle among the available options.
I CANNOT FIND THE VOLUME AND CHANNEL CHANGING BUTTONS	The buttons are represented by the ▲▼◀▶ buttons located on the remote control. ▲▼ changes the channels and ◀▶ changes the volume.
I CANNOT FIND ENTER BUTTON	The enter button has the symbol J. It is located in the center of the ▲▼◀▶ buttons.
TV TURNS OFF AUTOMATICALLY AFTER 5 MINUTES	The TV features a power saving mode which will automatically turn off the TV, if there's no signal provided for more than 5 minutes.

Important Information About the Anti-Reflective Window on your SunBriteTV Outdoor Television

The anti-reflective window on your all-weather TV is designed to dramatically reduce reflection and improve the contrast of the image on your TV. In order to preserve the anti-reflective properties of the window, it is imperative that you follow the maintenance guidelines below:

1. Clean the window by using the following directions:

To clean the SunBriteTV window, use glass cleaner and a lint-free or micro-fiber cloth. Spray the solution on the cloth and then apply to the window. DO NOT use acrylic cleaners.

2. When the TV is not in use, keep it covered with the SunBriteTV Outdoor Dust Cover

The fitted dust cover is constructed with weatherproof 4-ply polypropylene UV protection fabric that protects the window from direct and indirect sunlight, and keeps wind-blown objects from scratching the surface of the window.

To order the Dust Cover, contact your Authorized SunBriteTV dealer or SunBriteTV's Customer Service at 866.357.8688.

General Cleaning

Remove any dirt and salt deposits from the unit, being careful to rinse the cloth frequently to avoid scratching the TV or screen surface. Avoid using harsh chemicals, abrasives, or solvents when cleaning any surface on the unit.

Snow and Ice

Use a soft brush and towel to remove snow and ice from the unit.

Fiber Filter

In areas where dust or salt air is prevalent, it is recommended that the Fiber Filter be cleaned regularly.

The Fiber Filter is located on the back of the unit, inside the Intake Vent at the top of the TV (Figure 1).

1. Release the Fiber Filter by pulling it out from the corner of the Intake Vent (Figure 2). Notice how the Fiber Filter fits in the upper and lower channels, and tightly against the side.
2. Pull the Fiber filter out of the TV, and wash it with mild detergent and warm water. After rinsing, let the Fiber Filter dry completely.
3. Put the Fiber Filter back up into the Intake Vent pushing the filter first into the upper channel, then fit it into the lower channel. Make sure filter fits tightly against the side. (Figure 3).

Figure 1

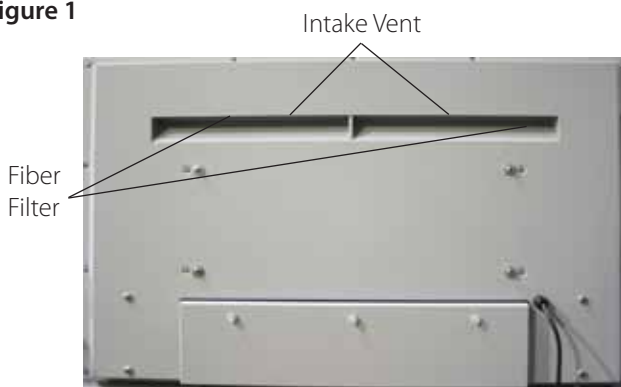


Figure 2



Figure 3

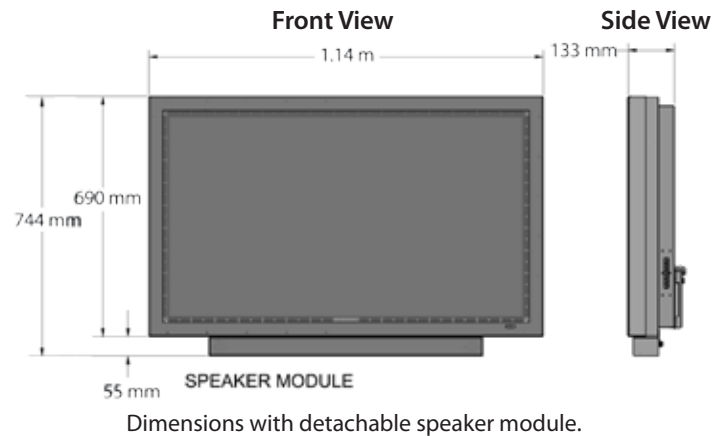


Specifications

Specifications for SunBriteTV Model 4610HD

Specifications

LCD Screen	46-inch diagonal TFT Active Matrix
Resolution	HD 1920 x 1080 Full HD 1080p
Aspect Ratio	16:9
Contrast Ratio	3000:1
Viewing Angle	178°
Response Time	6 milliseconds
TV formats	1080p, 1080i, 720p, 480p, 480i
Input Connectors:	
RF	Antenna / PAL DVB-J x1
HDMI	HDMI™ Input x3
Video Composite	S-Video x1 and Composite Video x1, L/R Audio Inputs x1
Video Component	YPbPr plus Stereo Audio x1
PC	15-pin D-sub VGA plus Stereo Audio
RS232 Serial	Full-featured command set with discrete on/off, input select and volume control
Discrete IR Control	Codes for Power On/Off and Input Select
Input Power	100-240 VAC, 50-60 Hz 4.0 A Max
Audio	10-watt x 2 channels, water-resistant speaker module (detachable); SPDIF Digital Audio Out; Analog 1/8" stereo mini jack out
Operating Temp.	-24° to 122° F. (-31° to 50° C.) *
Non-op. Temp. (Off-mode with power applied)	-24° to 140° F. (-31° to 60° C.) The non-operating temperature feature requires power to be applied
Accessories Included	Water-resistant remote control with long-life battery
TV Dimensions	1.14 m W x 690 mm H (744 mm H with speakers) x 133 mm D
Weight	37.5 kg.; 39.4 kg with speakers
Warranty	One-year, in-factory, parts and labor



Specifications are subject to change.

*Temperature range is for operation in shaded location.

PC Timing Codes

Up to 1920 x 1080@60Hz

Features Information and Instructions

Internal Thermostatically-Controlled Heater

The Internal Thermostatically-Controlled Heater keeps the unit warm in freezing temperatures and activates automatically when the SunBriteTV internal temperature sensor reads a temperature inside the unit of 0° C. or lower. The heater remains on until the internal temperature rises to at least 5.6° C. The heater provides a 6.6° C. temperature rise, allowing the TV to safely remain in temperatures as low as -31.1° C. The ventilation fans are not activated when the heater is running and will automatically activate when required.

If temperatures below -31.1° C. are expected, we recommend that you bring your SunBriteTV inside to prevent damage to the LCD screen.

Note: *In order for the automatic heater to work properly, your SunBriteTV must have power applied at all times.*

Programming Other Manufacturers' Universal Remote Control Devices

When programming a satellite TV, local cable universal remote control or control system, you may find that SunBriteTV may not be on the list of TV manufacturers. If that is the case, Model 5510HD supports SONY's universal remote code.

SunBriteTV Pixel Quality Policy

SunBriteTV's Pixel Quality Policy

SunBriteTV™ LCD screens are manufactured with rigorous standards to maintain optimal viewing. However, the LCD screen may have minor defects that appear as a small bright or dark pixel. This is common to all LCD screens used in display and television products, and is not specific to SunBriteTV.

Bright dots are dots that appear bright and unchanged in size when a LCD TV screen displays a black pattern.

Dark dots are dots that appear dark and unchanged in size when a LCD TV screen displays a pure red, green, or blue pattern.

Adjacent dots are pixels located directly next to each other.

Your SunBriteTV will be replaced under warranty if it meets one of the following criteria:

—A total of 7 defective pixels, including both bright dots and dark dots are present. (Model 5510HD LCD TV screen has over a million pixels.)

—2 or more pairs of adjacent bright dots are present.

—3 adjacent bright dots are present.

—3 adjacent dark dots are present.

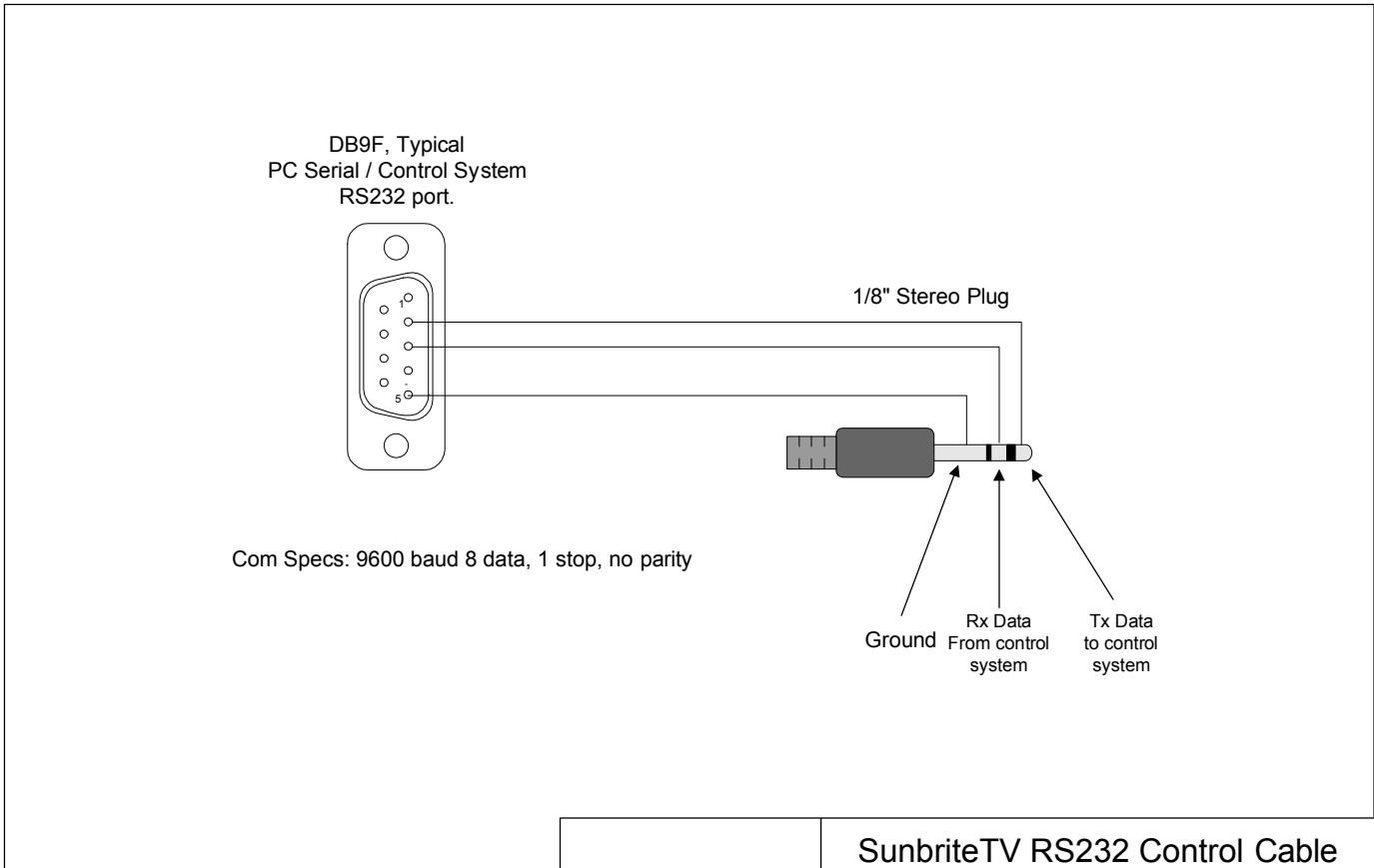
To locate defective pixels, the LCD panel should be examined under normal operating conditions, in its native display resolution, with a 90 degree viewing angle, from a distance of approximately 20 inches.

To qualify for replacement, a defective LCD screen must be reported to SunBriteTV within 14 days from the day the customer receives the TV.

Appendix A - RS232 Control Codes

Function	ASCII	HEX	Command Received Response from TV to control system	Command Executed Response from TV to control system
Firmware Version Number	[ESC]?	1B 3F	[B3220AHD-X.XX] or [B4610AHD-X.XX]	na
Power Status	[ESC]!	1B 21	[PWRON] [PWROFF]	na
Power Toggle	[ESC]\$	1B 24	[\$]	[PWR]
Power ON	[ESC]A	1B 41	[A]	[PWRON]
Power OFF	[ESC]B	1B 42	[B]	[PWROFF]
Tuner Input	[ESC]C	1B 43	[C]	[TN1]
Composite Video Input 1	[ESC]D	1B 44	[D]	[AV1(CVBS)]
S-Video Input 1	[ESC]E	1B 45	[E]	[AV1(S-VIDEO)]
Composite Video Input 2	[ESC]F	1B 46	[F]	[AV2(CVBS)]
S-Video Input 2	[ESC]G	1B 47	[G]	[AV2(S-VIDEO)]
Component1 Input	[ESC]H	1B 48	[H]	[YpbPr1]
Component2 Input	[ESC]I	1B 49	[I]	[YpbPr2]
HDMI Input 1	[ESC]J	1B 4A	[J]	[HDMI1]
VGA Input	[ESC]K	1B 4B	[K]	[VGA]
HDMI Input 2	[ESC]L	1B 4C	[L]	[HDMI2]
Mute	[ESC]X	1B 58	[X]	[MUTE]
Vol Up	[ESC]Y	1B 59	[Y]	[VOL+]
Vol Down	[ESC]Z	1B 5A	[Z]	[VOL-]
Channel Up	[ESC]V	1B 56	[V]	[CH+]
Channel Down	[ESC]W	1B 57	[W]	[CH-]
1	[ESC]1	1B 31	[1]	na
2	[ESC]2	1B 32	[2]	na
3	[ESC]3	1B 33	[3]	na
4	[ESC]4	1B 34	[4]	na
5	[ESC]5	1B 35	[5]	na
6	[ESC]6	1B 36	[6]	na
7	[ESC]7	1B 37	[7]	na
8	[ESC]8	1B 38	[8]	na
9	[ESC]9	1B 39	[9]	na
0	[ESC]0	1B 30	[0]	na
-	[ESC]-	1B 2D	[-]	na
Channel Return(Previous Channel)	[ESC]r	1B 72	[r]	na
Source Toggle	[ESC]b	1B 62	[SRC]	na
Aspect	[ESC]a	1B 61	[ASPECT]	na
Enter	[ESC]e	1B 65	[ENTER]	na
Info	[ESC]i	1B 69	[INFO]	na
CC	[ESC]c	1B 63	[CC]	na
Sleep	[ESC]z	1B 7A	[SLEEP]	na
Picture	[ESC]p	1B 70	[PICT]	na
Sound	[ESC]s	1B 73	[SND]	na
(4610 only) PIP On	[ESC]P	1B 50	[PIP]	na
(4610 only) PIP Source	[ESC]Q	1B 51	[PSC]	na
(4610 only) PIP Swap Video	[ESC]R	1B 52	[PSV]	na
(4610 only) PIP Swap Audio	[ESC]S	1B 53	[PSA]	na
(4610 only) PIP Size	[ESC]T	1B 54	[PSZ]	na

Appendix B - RS232 Control Cable Pinout



This page is intentionally left blank.

This page is intentionally left blank.

